

ANTI-VIBRATION

LEVELING MOUNTS

Self aligning leveling mounts compensate for uneven floors or mounting deflection. Made from oil resistant non-skid, ribbed neoprene rubber. VS series are used where maximum dampening of shock is required or to prevent creeping and walking of workshop machines.

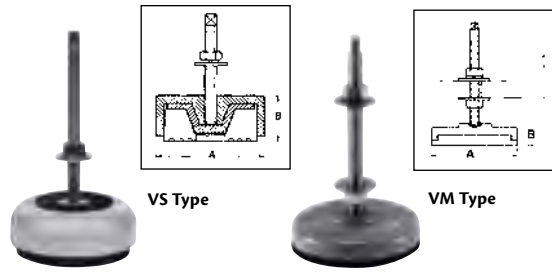

Model No.	Type	Maximum Load in lbs.		Leveling Adjustment"	Leveling Bolt Sizes"	Mount Dimensions		Price /Each
		Non-Impact Machinery	Impact			A"	B"	
UD172	VM	500	350	1.0	1/2NC x6	4.0	1	
TP197	VM	1000	700	1.0	1/2NC x6	4.0	1	
UA279	VM	2000	1400	1.0	5/8NC x8	4.0	1	
UA278	VM	2000	1400	1.0	3/4NF x6	7.0	1 1/4	
UA277	VM	4000	2800	1.0	3/4NF x6	7.0	1 1/4	
UA276	VM	8000	5600	1.0	3/4NF x6	7.0	1 1/4	
UA297	VM	12000	8500	1.0	1NS x8	7.0	1 1/4	
UD170	NVS	1500	1000	1/2	1/2NC x6	3.5	1 1/2	
UD171	NVS	4500	3000	1/2	5/8NC x8	5.5	2	
UA290	NVS	15000	7000	1/2	1NS x8	9	2 1/4	
UA289	NVS	15000	17000	1/2	1NS x8	9	2 1/4	

VIBRA-WEDGE ISOLATORS

- Designed for the installation and precision levelling of heavy industrial machinery
 - 3 machined wedges are mounted and held together by a horizontal adjusting bolt
 - A lock screw secures the mount in the levelled position
 - A special opening allows for bolting of the machine to the floor
- Note:** Max. levelling is 1/4" (6 mm). If more height is required use a shim plate.

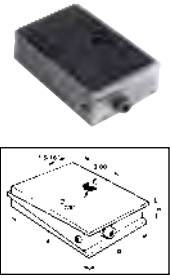

Model No.	A mm	B mm	H mm	Max. Load lbs.	Price /Each
UP587	150	100	40+/-5	15000	
UP588*	150	100	50+/-5	9000	

*Neoprene top and bottom included.

ANTI-VIBRATION CUPMOUNTS

Industrial cupmounts provide excellent protection against severe impact shock, vibration and noise

- High vibration dampening characteristics
- Fail-safe, rugged interlocking metal and neoprene construction provides exceptional performance against shear and compression forces and flexible vertically and stable horizontally
- Metal cupmount component is cold-rolled steel coupled with an elastomer-in-compression design
- High-grade neoprene elastomer provides resistance to oil and ozone
- Each side flange has through holes allowing for effective attachment to supporting equipment structure

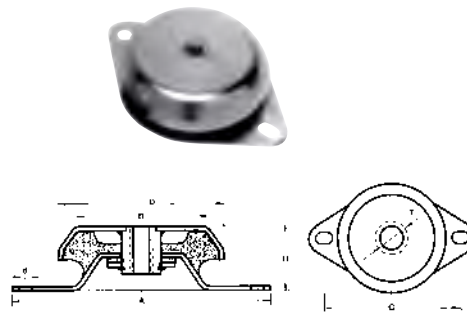

Model No.	Maximum load in lbs.		Mount Dimensions			d"	T"	Price /Each	
	Non-impact Machinery	Impact	A"	B"	C"				
UD185	400	250	6	2 3/4	5	3 5/8	1 3/8	0.390	1/2 - 13
UD186	700	450	6	2 3/4	5	3 5/8	1 3/8	0.390	1/2 - 13
UD187	1400	900	7 11/16	4	6 3/8	5 3/16	1 11/16	0.550	5/8 - 11
UD188	2600	1700	7 11/16	4	6 3/8	5 3/16	1 11/16	0.550	5/8 - 11

NEOPRENE VIBRATION PADS

Install machinery and equipment on double sided moulded neoprene pads to isolate vibration, shock and reduce noise level. Waffle design allows material expansion without losing stability. Pads should be cut to the size of machines feet allowing 1/2" margin on all sides. Pads resist oil and solvents.

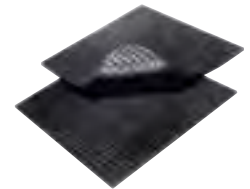

Model No.	Load Range	Size"	Price /Each
UA295	1-25 PSI	18 x 18 x 5/16	
UA291	10-50 PSI	18 x 18 x 5/16	
UA270	40-100 PSI	18 x 18 x 5/16	
UD168	75-200 PSI	18 x 18 x 1/2	
UA292	150-300 PSI	18 x 18 x 1/2	
UA273	1-25 PSI	6 x 6 x 5/16	
UA271	10-50 PSI	6 x 6 x 5/16	
UA275	40-100 PSI	6 x 6 x 5/16	
UA274	75-200 PSI	6 x 6 x 1/2	
UA296	150-300 PSI	6 x 6 x 1/2	

CYLINDRICAL VIBRATION ISOLATORS

- Natural rubber isolators can be used on all industrial motors, compressors, fans and machinery
- Not suitable for wall or ceiling mounting applications or with use in oil or solvent soaked environments

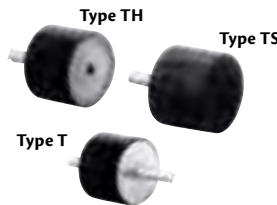

Model No.	Type	Dimensions mm				Load Cap. lbs.	Price /Each
		A	B	C	D		
UA280	T	20	15	M-6	13	55	
UD167	T	20	25	M-6	13	50	
UA282	T	25	30	M-8	20	75	
UA283	T	30	30	M-8	20	175	
UA284	T	35	35	M-8	20	195	
UA285	T	40	30	M-10	25	330	
UA286	T	40	40	M-8	25	260	
UA287	TH	20	15	M-6	13	55	
UA293	TH	25	25	M-8	20	85	
UA294	TH	30	30	M-8	20	175	
UA298	TS	20	15	M-6	13	55	
UA299	TS	25	25	M-8	20	85	
UA288	TS	30	30	M-8	20	175	
UA300	TS	40	30	M-10	25	330	

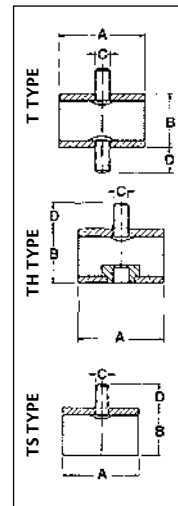



SLOTTED SHIMS

- Slotted shim is the best way to solve alignment and leveling problems
- Shims conform to standard bolt and stud sizes
- Each shim marked with thickness in decimal and metric
Thicknesses up to 0.010" are permanently etched
Thicknesses over 0.015" are permanently stamped
- 300 series stainless steel material resists rust and corrosion



SLOTTED SHIMS ASSORTMENTS

Full and mini assortments come in durable metal boxes.
Shop kits are packaged in a sturdy chipboard box

- A. Full Assortment:** Contains 260 Pcs. 20 each of 13 sizes (0.001", 0.002", 0.003", 0.004", 0.005", 0.010", 0.015", 0.020", 0.025", 0.050", 0.075", 0.100", 0.125")
- B. Mini Assortment:** Contains 130 Pcs., 10 each of 13 sizes (0.001", 0.002", 0.003", 0.004", 0.005", 0.010", 0.015", 0.020", 0.025", 0.050", 0.075", 0.100", 0.125")
- C. Shop Kit:** Contains 80 Pcs., 10 each of 8 sizes (0.001", 0.003", 0.005", 0.010", 0.015", 0.020", 0.025", 0.075")

ASSORTMENTS

	2" x 2"	3" x 3"	4" x 4"	5" x 5"
	Model No.	Model No.	Model No.	Model No.
A.	GR264	GR265	GR266	GR267
B.	GR268	GR269	GR270	GR271
C.	GR272	GR273	GR274	GR275

SLOTTED SHIMS INDIVIDUAL PACKAGES

Thickness"	Pcs Per Pkg	2" x 2"		3" x 3"		4" x 4"		5" x 5"	
		Model No.	Price /Each	Model No.	Price /Each	Model No.	Price /Each	Model No.	Price /Each
0.001	20	GR276		GR289		GR302		GR315	
0.002	20	GR277		GR290		GR303		GR316	
0.003	20	GR278		GR291		GR304		GR317	
0.004	20	GR279		GR292		GR305		GR318	
0.005	20	GR280		GR293		GR306		GR319	
0.010	20	GR281		GR294		GR307		GR320	
0.015	10	GR282		GR295		GR308		GR321	
0.020	10	GR283		GR296		GR309		GR322	
0.025	10	GR284		GR297		GR310		GR323	
0.050	5	GR285		GR298		GR311		GR324	
0.075	5	GR286		GR299		GR312		GR325	
0.100	5	GR287		GR300		GR313		GR326	
0.125	5	GR288		GR301		GR314		GR327	

SLOTTED SHIM SLOT SIZES

2" x 2"	3" x 3"	4" x 4"	5" x 5"
5/8"	3/4"	1 1/4"	1 5/8"

SLOTTED SHIM TOLERANCES

Thickness"	Tolerance"
0.001	± 0.00008
0.002	± 0.0001
0.003	± 0.00015
0.004	± 0.0002
0.005	± 0.00025
0.010-0.020	± 0.0005
0.025	± 0.00075
0.05	± 0.001
0.075 & 0.100	± 0.002
0.125	± 0.0025

SHIM STOCK ROLLS & SHEETS

- Precision Brand steel shim stock is a full hard, cold rolled, low carbon 1010
- Rockwell hardness: RB90-100
- Approx. tensile strength: 80 000 PSI
- Meets ASTM A-109, AISI 1010

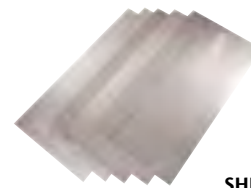

ROLLS (1 ROLL PER PKG.)

Thickness"	STEEL 6" x 100"		STAINLESS STEEL 6" x 50"		BRASS 6" x 100"	
	Model No.	Price /Each	Model No.	Price /Each	Model No.	Price /Each
0.0005	-	-	GR350	-	-	-
0.0010	GR328	-	GR351	-	GR367	-
0.0015	GR329	-	GR352	-	GR368	-
0.0020	GR330	-	GR353	-	GR369	-
0.0025	GR331	-	-	-	-	-
0.0030	GR332	-	GR354	-	-	-
0.0035	GR333	-	-	-	-	-
0.0040	GR334	-	GR355	-	GR371	-
0.0050	GR335	-	GR356	-	GR372	-
0.0060	GR336	-	GR357	-	GR373	-
0.0070	GR337	-	GR358	-	GR374	-
0.0080	GR338	-	GR359	-	GR375	-
0.0090	GR339	-	GR360	-	GR376	-
0.0100	GR340	-	GR361	-	GR377	-
0.0120	GR341	-	GR362	-	GR378	-
0.0135	GR342	-	-	-	-	-
0.0150	GR343	-	GR363	-	GR379	-
0.0165	GR344	-	-	-	-	-
0.0180	GR345	-	-	-	GR380	-
0.0200	GR346	-	GR364	-	GR381	-
0.0220	GR347	-	-	-	-	-
0.0250	GR348	-	GR365	-	GR382	-
0.0310	GR349	-	GR366	-	GR383	-

SHEETS (10 SHEETS PER PKG.)

Thickness"	STEEL 6" x 18"		STAINLESS STEEL 6" x 25"		BRASS 6" x 18"	
	Model No.	Price /Each	Model No.	Price /Each	Model No.	Price /Each
0.0010	GR384	-	-	-	GR413	-
0.0015	GR385	-	-	-	GR414	-
0.0020	GR386	-	-	-	GR415	-
0.0025	GR387	-	-	-	-	-
0.0030	GR388	-	-	-	GR416	-
0.0035	GR389	-	-	-	-	-
0.0040	GR390	-	-	-	GR417	-
0.0050	GR391	-	-	-	GR418	-
0.0060	GR392	-	-	-	GR419	-
0.0070	GR393	-	-	-	GR420	-
0.0080	GR394	-	GR406*	-	GR421	-
0.0090	GR395	-	-	-	GR422	-
0.0100	GR396	-	GR407*	-	GR423	-
0.0120	GR397	-	GR408*	-	GR424	-
0.0135	GR398	-	-	-	-	-
0.0150	GR399	-	GR409*	-	GR425	-
0.0165	GR400	-	-	-	-	-
0.0180	GR401	-	-	-	GR426	-
0.0200	GR402	-	GR410*	-	-	-
0.0220	GR403	-	-	-	-	-
0.0250	GR404	-	GR411*	-	GR427	-
0.0310	GR405	-	GR412*	-	GR428	-

*Stainless Steel Sheets sold in pack of 2

SHIM TOLERANCES

Thickness"	Tolerance"
STEEL	
0.001 - 0.003	± 10%
0.0035 - 0.006	± 0.0005
0.007 - 0.018	± 0.00075
0.020 - 0.025	± 0.001
0.031	± 0.0015
Width Tolerance	± 0.005
STAINLESS STEEL	
0.0005-0.010	± 10%
0.011 - 0.019	± 0.001
0.020 - 0.028	± 0.0015
0.029 - 0.031	± 0.002
Width Tolerance	± 0.005
BRASS	
0.001 - 0.003	± 10%
0.004	± 0.0003
0.005 - 0.006	± 0.0004
0.007 - 0.009	± 0.0006
0.010 - 0.013	± 0.0008
0.014 - 0.017	± 0.0010
0.018 - 0.021	± 0.0013
0.022 - 0.031	± 0.002
Width Tolerance	± 0.008

SHIM STOCK ASSORTMENTS

Model No.	Type	Description	Price/Each
-----------	------	-------------	------------

SHIM STOCK SHEET ASSORTMENTS

GR431	Stainless Steel Sheet Assortment	Contains 8 sheets 6" x 12", one sheet of each: 0.001", 0.002", 0.003", 0.005", 0.008", 0.010", 0.015", 0.020"	
GR432	Brass Sheet Assortment	Contains 12 sheets 6" x 18" one sheet of each: 0.001", 0.0015", 0.002", 0.003", 0.004", 0.005", 0.006", 0.007", 0.008", 0.010", 0.012", 0.015"	
GR433	Steel Sheet Assortment	Contains 12 sheets 6" x 18", one sheet of each: 0.001", 0.0015", 0.002", 0.003", 0.004", 0.005", 0.006", 0.007", 0.008", 0.010", 0.012", 0.015"	

SHIM STOCK ROLL ASSORTMENTS

GR429	Steel Roll Assortment	Contains 4 rolls per assortment 6" x 50" (Includes one roll of each: 0.001", 0.002", 0.003", 0.005")	
GR430	Brass Roll Assortment	Contains 4 rolls per assortment 6" x 50" (Includes one roll of each: 0.001", 0.002", 0.003", 0.005")	

SHIMS & GAUGES

COLOUR-CODED PLASTIC SHIM STOCKS

- Precision Brand colour-coded shim is made from high quality plastic material
- Resist oil, easy to cut, minimal compression during use
- Thickness to industry standards
- Non conductive to electricity

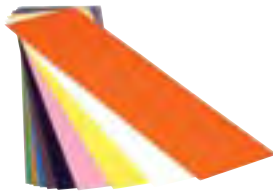

PLASTIC SHIM STOCK COLOUR-CODED

Thickness		Colour	Qty. Pkg.	5" x 20"		10" x 20"	
Inch	cm			Model No.	Price /Each	Model No.	Price /Each
0.0005	0.013	Silver	5	GR434		GR451	
0.0010	0.0250	Amber	5	GR435		GR452	
0.0015	0.0380	Purple	5	GR436		GR453	
0.0020	0.0510	Red	5	GR437		GR454	
0.0030	0.0760	Green	5	GR438		GR455	
0.0040	0.1020	Tan	10	GR439		GR456	
0.0050	0.1270	Blue	10	GR440		GR457	
0.0075	0.1910	Matte	10	GR441		GR458	
0.0100	0.2540	Brown	10	GR442		GR459	
0.0125	0.3180	Black	10	GR443		GR460	
0.0150	0.3810	Pink	10	GR444		GR461	
0.0200	0.5080	Yellow	10	GR445		GR462	
0.0250	0.6350	White	10	GR446		GR463	
0.0300	0.7620	Coral	10	GR447		GR464	
0.0400	1.0160	Clear	3	GR448		GR465	
0.0500	1.2700	Clear	3	GR449		GR466	
0.0600	1.524	Clear	3	GR450		GR467	

PLASTIC SHIM STOCK COLOUR-CODED ASSORTMENTS

Each assortment contains 1 each of the following: 0.0005", 0.001", 0.0015", 0.002", 0.003", 0.004", 0.005", 0.0075", 0.010", 0.015", 0.020", 0.025", 0.030"

Model No.	Description	Price/Each
GR468	5" x 20" 14 sheets	
GR469	10" x 20" 14 sheets	

FEELER GAGE STOCKS

- Precision Brand feeler gage is made from 1/2" wide spring steel stock, close grain C1095 high-carbon steel
- Hardened and tempered to RC 48-62
- Thickness clearly etched
- Material is ground and polished to precision tolerances
- 12 pieces per box



FEELER GAGE STOCK FLAT LENGTHS 1/2" X 12"

Model No.	Thickness Inch	Thickness cm	Price /Each	Model No.	Thickness Inch	Thickness cm	Price /Each
GR470	0.0010	0.0250		GR487	0.0160	0.4060	
GR471	0.0015	0.0380		GR488	0.0170	0.4320	
GR472	0.0020	0.0510		GR489	0.0180	0.4570	
GR473	0.0025	0.0640		GR490	0.0190	0.4830	
GR474	0.0030	0.0760		GR491	0.0200	0.5080	
GR475	0.0040	0.1020		GR492	0.0210	0.5330	
GR476	0.0050	0.1270		GR493	0.0220	0.5590	
GR477	0.0060	0.1520		GR494	0.0230	0.5840	
GR478	0.0070	0.1780		GR495	0.0240	0.6100	
GR479	0.0080	0.2030		GR496	0.0250	0.6350	
GR480	0.0090	0.2290		GR497	0.0280	0.7110	
GR481	0.0100	0.2540		GR498	0.0300	0.7620	
GR482	0.0110	0.2790		GR499	0.0310	0.7870	
GR483	0.0120	0.3050		GR500	0.0320	0.8130	
GR484	0.0130	0.3300		GR501	0.0340	0.8640	
GR485	0.0140	0.3560		GR502	0.4000	1.0160	
GR486	0.0150	0.3810					

STEEL FEELER GAGE ASSORTMENT

The "Big Poc-Kit" Assortment
Contains 20 Blades - 1/2" X 12" including case

Model No. GR503
Price/Each \$



KEY STOCKS



ZINC PLATED

Model No.	Size"	Length"	Price /Each
GR183	3/32	12	
GR184	1/8	12	
GR185	5/32	12	
GR186	3/16	12	
GR187	7/32	12	
GR188	1/4	12	
GR189	9/32	12	
GR190	5/16	12	
GR191	3/8	12	
GR192	7/16	12	
GR193	1/2	12	
GR194	9/16	12	
GR195	5/8	12	
GR196	11/16	12	
GR197	3/4	12	
GR198	13/16	12	
GR199	7/8	12	
GR200	1	12	
GR201	1-1/8	12	
GR202	1-3/16	12	
GR203	1-1/4	12	
GR204	1-3/8	12	
GR205	1-1/2	12	
GR206	1-3/4	12	
GR207	2	12	



- Steel keystock is used to provide driving torque between shafts and pulleys, gears, sprockets, etc.
- Material is high-quality, cold-drawn, low carbon C1018 steel
- Most tolerances on material are oversized to assure tight fit in keyways for positive, zero backlash power transmission
- Meets ASTM standard A-108

ZINC-PLATED KEYSTOCK TOLERANCES

Size"	Square"
3/32 - 5/8	+0.003/-0
11/16	+0.001/-0.004
3/4	+0.003/-0
13/16 - 1-1/2	+0.004/-0
1-3/4 - 2	+0.005/-0

STAINLESS STEEL

Model No.	Fraction Size"	Metric Size mm	Length"	Price /Each
GR251	1/8	3.18	12	
GR252	3/16	4.76	12	
GR253	1/4	6.35	12	
GR254	5/16	7.94	12	
GR255	3/8	9.53	12	
GR256	7/16	11.11	12	
GR257	1/2	12.70	12	
GR258	5/8	15.88	12	
GR259	3/4	19.05	12	
GR260	7/8	22.23	12	
GR261	1	25.40	12	

STAINLESS STEEL KEYSTOCK ASSORTMENT

Model No.	Sizes"	Length"	Qty Each	Price /Each
	3/16	12	4	
	1/4	12	4	
	5/16	12	4	
GR262	3/8	12	4	
	7/16	12	4	
	1/2	12	4	

ZINC-PLATED KEYSTOCK ASSORTMENT

Model No.	Sizes"	Length"	Qty Each	Price/Each
	3/16	12	6	
	5/16	12	6	
GR208	7/16	12	4	
	1/2	12	4	